

MEDICAL-PHARMACEUTICAL REFRIGERATOR

MPR 1365 W (White finishing)

MPR 1365 S (Stainless steel finishing)

- **Structure:** upright type, realized in sheet steel with special anti-bacterial epoxy coating white colour both in- and outside or in stainless steel 18/10 AISI 304 both in- and outside. All the internal corners are rounded to make easy any cleaning operations and the internal bottom is tray type to contain spills
- **Insulation:** high density (40 Kg/m³) foamed-in-place polyurethane, with a thickness of 75 mm. CFC-free
- **Feet:** Nr 4 made in stainless steel 18/10 AISI 304, adjustable in height for levelling
- **Glass doors:** Nr 2, hinged, side-by-side, made a perimetrical aluminium frame and three layers of tempered insulating glass, with vacuum among the glass layers in order to increase the insulating rate. The doors are provided with a removable magnetic rubber gasket in order to grant a perfect hermetic closing. The handles are realized in aluminium, integrated in the door profile, full-height for an higher comfort of use. The doors are also fitted with a spring loaded automatic closing device for openings inferior then 90° and special door switches that stop the internal ventilation at the door opening (to limit the air cold loss)
- **Internal equipment:** Nr 6 (3 for each door) storage open wire shelves realized in sheet steel with a strong plastic coating (rust-proof material). The shelves are mounted on special anti-tilt stainless steel slides that allow the shelf extraction and they can be easily removed and adjusted in height without the use of any tool. The special internal racking-system allows a great flexibility of the internal fitting with the possibility of interchange and combine both shelves and drawers (drawers optionally available)
 - Shelf dimensions (W x D cm): 53 x 65
 - Shelf loading capability (Kg): 35 (with uniformly stored material)
- **Internal lighting:** Nr 2 LED tubes, mounted in the side walls, with automatic activation both at every door opening and even through a touchpad on the control panel. They grant energy saving and prevent the internal heating produced by the traditional neon tubes
- **Control panel:** located in the top part of the structure (above the door), it is microprocessor operating with 6 soft-touchpads and LED display, allowing the control of all the functions and working status of the refrigerator (including alarms). The main functions of the control panel are:
 - LED display, with bright indication, red colour, of the actual internal temperature and enlightened icons in green colour indicating the appliance working status (compressor functioning, defrosting, fan running, etc.)
 - Digital temperature adjusting and displaying with an accuracy of 0,1°C
 - Keyboard buttons with locking protection, manually activable, to avoid tampering from unauthorized persons
 - Visual and acoustic alarm signalling (with automatic resetting) for:
 - high and low temperature with limits programmable from the user
 - door ajar, delayed to allow the standard operations
 - power failure (at the return of the mains supply)
 - anti-freezing evaporator
 - sensors failure
 - Muting facilities for the acoustic alarms with maintaining of the visual indication of the alarm condition

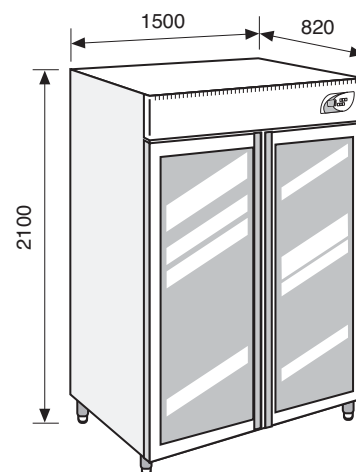











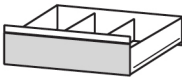

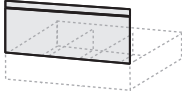

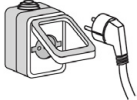
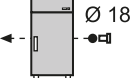
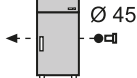

**MEDICAL-PHARMACEUTICAL
REFRIGERATOR**

- Alarms memory for the last 10 alarm conditions, with the possibility of checking from the display, the sort of alarm, when the alarm is started, when it is ended and which is the highest or lowest peak reached from the temperature (where applicable)
- Ntc type sensors for a high accuracy of the temperature control
- NC contact to remote the alarm signals
- **Cooling unit:** top mounted, with the condensing unit compounded by Nr 1 hermetic compressors and Nr 1 finned condenser, air cooled through a fan. Also, in the ceiling of the storage chamber, is mounted the finned evaporator with copper pipes, that is housed into a stainless steel cover that incorporate the fan. All the mounted components are industrial grade to grant the maximum reliability
- **Refrigerant:** R452 (R404a) CFC-free
- **Refrigeration:** forced-air, through a fan, granting the maximum temperature uniformity and stability inside of the cabinet
- **Defrosting:** completely automatic, thermostat controlled. The condensate water is automatically channelled into an heated tray, located in the cabinet backside, for the automatic evaporation of the condensate water
- **Temperature range:** infinitely adjustable between +2°C / +15°C
- **Voltage (V/ph/Hz):** 220-230/1/50
- **Plug:** Schuko type (type F+E)
- **Breakers:** Nr 2 glass cartridge fuses with a rating of 10A, at protection of the appliance
- **Noise level (dB(A)):** ≤ 52
- **Gross capacity (litres):** 1500 (52.95 cu.ft.)
- **Net capacity (litres):** 1365 (48.18 cu.ft.)
- **Dimensions (W x D x H cm):** 150 x 82 x 210
- **Net weight (Kg):** 250
- **Packed dimensions (W x D x H cm):** 158 x 98 x 224 (3,47 m³)
- **Gross weight (Kg):** 280

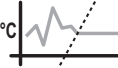
MEDICAL-PHARMACEUTICAL REFRIGERATOR

ACCESSORIES AVAILABLE

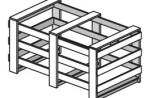
	Extra wire shelf		Extra stainless steel wire shelf
	Wire basket		Stainless steel drawer
	Plastic partitions for drawers		Front top for drawers
	Kit of castors		Safety door lock with key
	Temperature chart recorder		Internal electrical socket
	Cable port with cover Ø 18 mm		Cable port with cover Ø 45 mm
	Internal spark-proofing		Air sterilization lamp
	Safety anti-freezing thermostat		Temperature uniformity and stability kit
	Natural refrigerant R290		GSM/GPRS telephone dialer
	230V / 60 Hz Different voltage		115V / 60 Hz Different voltage
	Wooden crate packing		

* The declared performances are referred at +35°C ambient temperature, relative humidity of 70% and without any internal thermal mass (empty cabinet).

* Should it be necessary or useful without undermining any model essential features, technical and stylistic characteristics are subject to be changed without manufacturer's previous notice.